

The Bike Storage Company

Semi Vertical Cycle Rack

Tel: 0800 246 1723

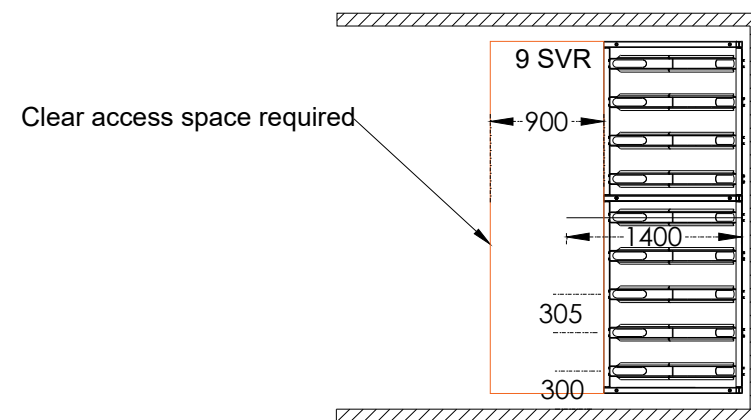
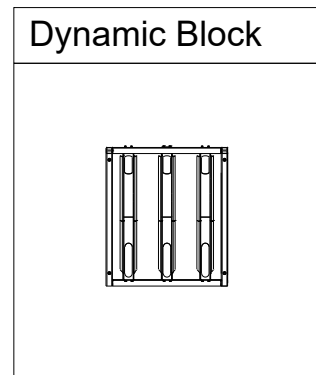

Min. aisle width: 1100mm
 Clear access space in front of rack: 900mm
 Spacing between racks: 305mm (Bespoke centres available)
 Centre of rack leg to wall tolerance: 300mm
 Minimum ceiling height: 2000mm

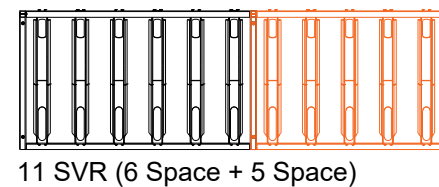
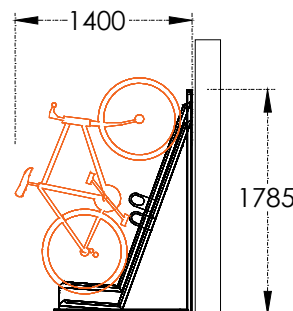
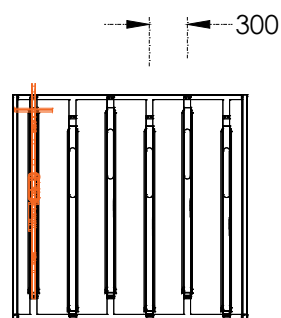
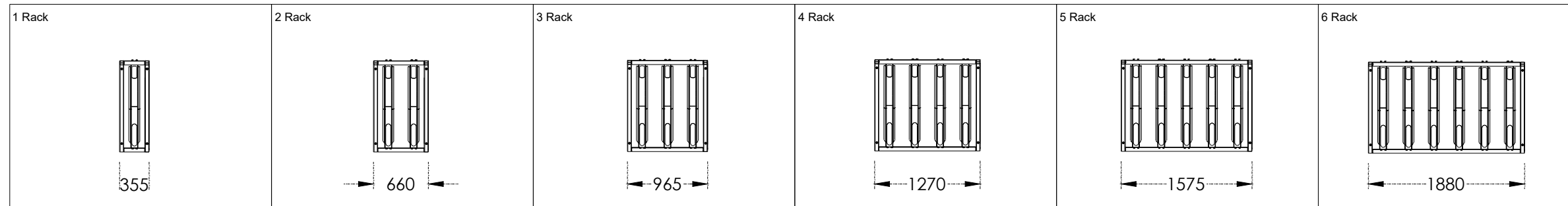

Runs over 6 spaces,
 rack legs can be shared
 to reduce overall width

Layout Breakdown		
Spaces	No. of Legs	Configuration
7	3	4 + 3
8	3	4 + 4
9	3	5 + 4
10	3	5 + 5
11	3	6 + 5
12	3	6 + 6
13	4	5 + 5 + 3
14	4	5 + 5 + 4
15	4	5 + 5 + 5
16	4	5 + 5 + 6
17	4	6 + 6 + 5
18	4	6 + 6 + 6
19	5	5 + 5 + 5 + 4
20	5	5 + 5 + 5 + 5

Legend:

Semi Vertical Cycle Rack

ALL DIMENSIONS ARE IN MM UNLESS OTHERWISE STATED. IF IN DOUBT PLEASE ASK.

THIS DRAWING IS CONFIDENTIAL AND IS THE PROPERTY OF THE BIKE STORAGE COMPANY. IT MUST NOT BE COPIED OR DISCLOSED TO A THIRD PARTY WITHOUT PERMISSION.

THE BIKE STORAGE COMPANY, MARINA STUDIOS, HARBOUR YARD, LONDON, SW10 0XD



THE BIKE STORAGE COMPANY
 0800 246 1723

Client: The Bike Storage Company

Status: Approval

Date Drawn: 23/03/2023

Draftsperson: W Martin

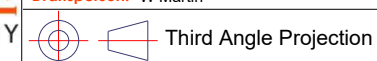

Project: Semi Vertical 2D CAD Model

Title: TBSC_SemiVertical_CAD_01

Scale: 1:60 @ ISO A3

DWG No: 1.0

Revision: 00